

Assembly Instruction

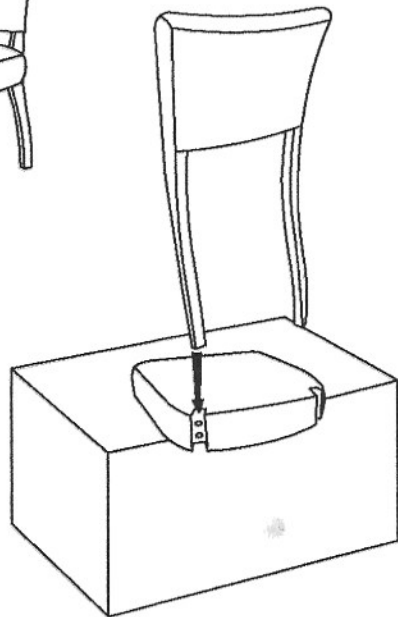

Step1:
Put the seat pad on the table(height > 50cm), insert the rear legs to the seat gap and move down till hole to hole, Screw the bolts.

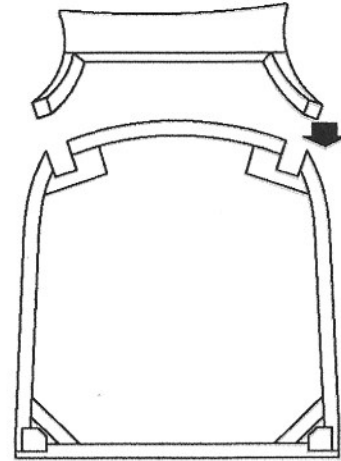



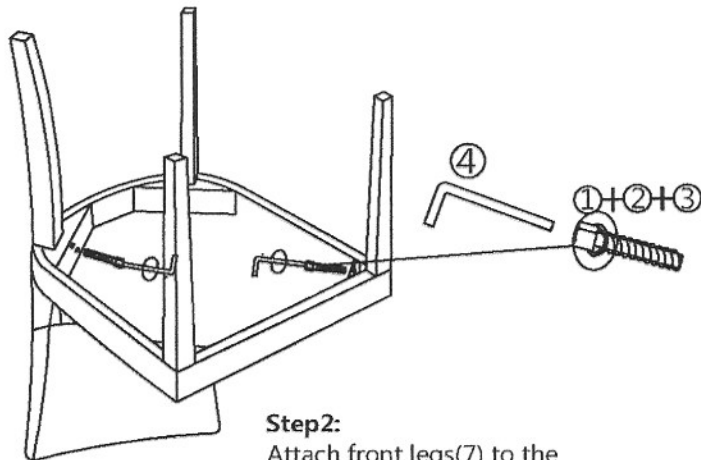

OR



Step1:
Step on the seat pad and support with your knee, insert the rear legs to the seat gap and pull till hole to hole, screw the bolts.

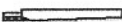

Step2:
Attach front legs(7) to the seat pad(6) as show in diagram.

| | | | |
|---|---|---|---|
| ①  X-8 | ②  X-8 | ③  X-8 | ④  X-1 |
| ⑤  X-1 | ⑥  X-1 | ⑦  X-2 | |